

What's in the Box?

- ▶ 1 x KDC SmartSled Pistol Grip Adaptor
- ▶ 1 x Pistol Grip
- ▶ 1 x 6000mAh Li-Polymer Battery
- ▶ 4 x screws + 1 extra

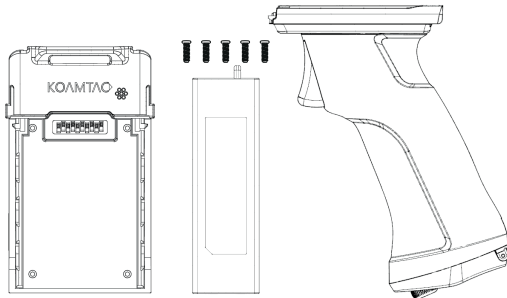

*KDC SmartSled sold separately.
Tweezers and PH0 screwdriver (not included)
will be necessary to complete assembly.

Additional Accessories

- ▶ KDC SmartSled 1-Slot Charging Cradle
- ▶ KDC SmartSled 5-Slot Charging Cradle
- ▶ HF Reader Companion
- ▶ 0.5W UHF Reader Companion
- ▶ 1.0W UHF Reader Companion
- ▶ Extended Battery



116 Village Blvd, Ste 305, Princeton, NJ 08540
+1 609-256-4700 p | +1 609-228-4373 f
info@koamtac.com | www.koamtac.com



Pistol Grip Assembly Manual for KDC SmartSled Scanners

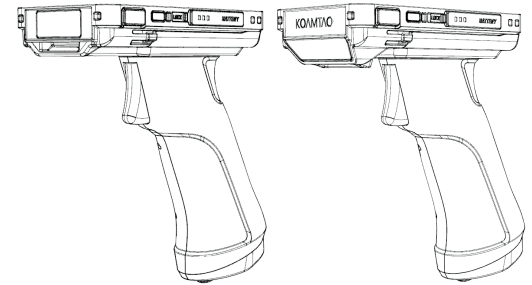

* For KDC470/475/480/485 SmartSled Scanners.

Assembly Instructions:

1. Using tweezers, carefully remove all four (4) screw caps from the back of the KDC SmartSled. (A)

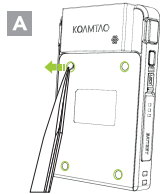

2. Remove all four (4) screws from the back of the KDC SmartSled. (B)

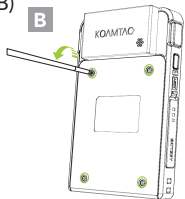

3. Remove the cover plate from the back of the KDC SmartSled. (C)



4. Align the screw holes of the Pistol Grip Adapter with the screw holes of the KDC SmartSled. Use the four (4) included screws to attach the Pistol Grip Adaptor to the KDC SmartSled. (D)



5. Align the notch in the top of the Pistol Grip with the top notch of the Pistol Grip Adaptor. (E)

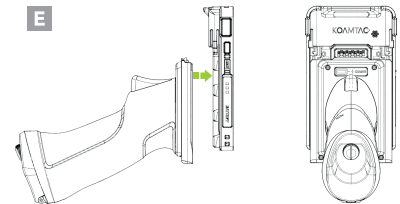

6. Slide Pistol Grip up until it clicks. (F)

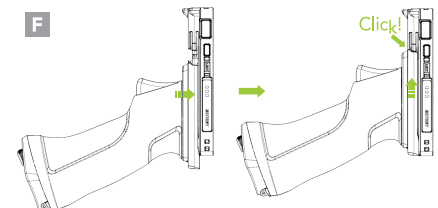

Removing Extended Battery

Squeeze the tabs on both sides of the Pistol Grip Adaptor and slide the Pistol Grip down. Pull the Pistol Grip away from the Pistol Grip Adaptor and KDC SmartSled. (G)

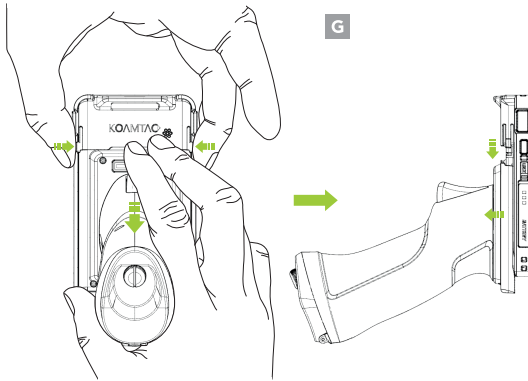

3. Close the battery door and turn the battery door knob clockwise to lock. (J)



Inserting the 6000mAh Li-Polymer Battery

1. Turn the knob on the bottom of the Pistol Grip counter-clockwise to open the battery door. (H)

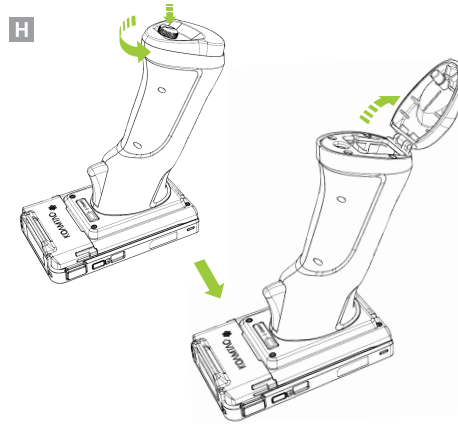

2. Insert the battery into the Pistol Grip. (I)

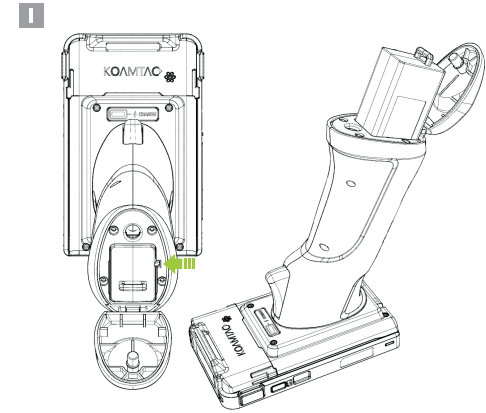

Pistol Grip Battery Indicator Status

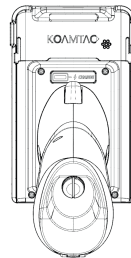

- * When Charging
 - Green: Fully Charged
 - Orange: Charging
 - Red : Low Battery
- * When In Use
 - Blinking Green: Fully Charged
 - Blinking Orange: Discharging
 - Blinking Red: Low Battery

KDC SmartSled with Pistol Grip

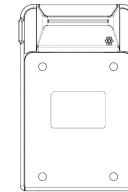

KDC SmartSled

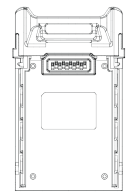

Option Adaptor

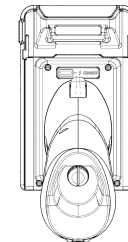

Assembled View

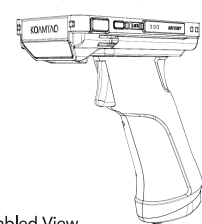

*Assembly procedure is the same for KDC470/475/480/485 models.
20220301 933330